

3 PIN CONNECTOR

LA-2001

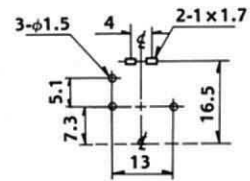

**P.C.B. LAYOUT
(BOTTOM VIEW)**

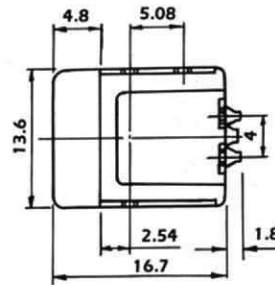
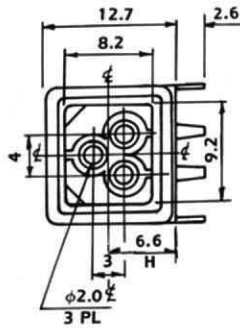
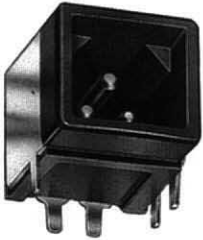
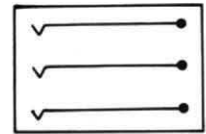

LA-2003

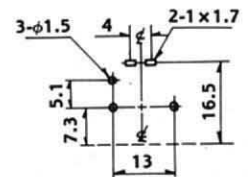
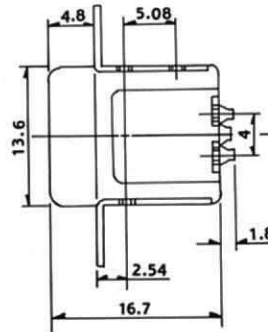
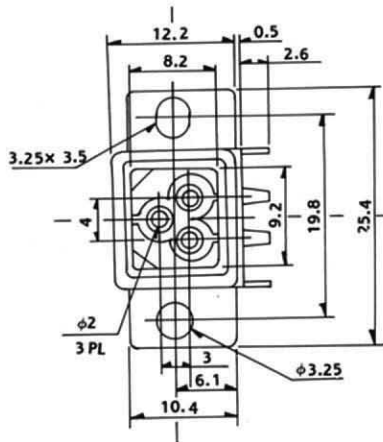
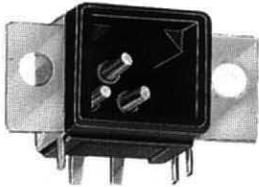

**P.C.B. LAYOUT
(BOTTOM VIEW)**

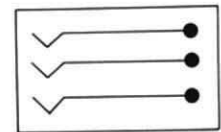

MATING PLUG

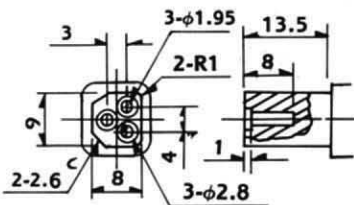

REQUIREMENTS

- CONTACT RESISTANCE: 30mΩ max. (INITIAL)
- INSULATION RESISTANCE: 100MΩ min. AT 500V DC.
- WITHSTANDING VOLTAGE: 500V AC FOR ONE MINUTE.
- SOLDERING HEAT TEST: 260±5°C FOR 5±1 SECONDS.
- INSERTION FORCE: 7.2 KGS max.
- EXTRACTION FORCE: 1.2 KGS min.
- LIFE TIME: 5,000 CYCLES min.